



健豪興業有限公司
ALL RIGHT ALL RIGHT ENTERPRISE CO., LTD.

- Quality
- Service
- Professional



健豪興業有限公司
ALL RIGHT ENTERPRISE CO., LTD.



健豪成立於1996年於新北市土城區，2007年遷廠於新北市樹林區，因應業務需要於2012年購地建廠於桃園市八德區現址，廠房面積826平方公尺，專業製造 Round Cables (SCSI , RS232 , VGA , Audio , DC , USB 2.0 & 3.0 , SATA , DVI , HDMI , Display Port , Type C , 安防線材, 防水線材 PoE...等) Flat Cables , Adaptors , Wire Harnesses and OEM Cables · 致力於滿足並供給各國際及最新電子工業！

我們在台灣八德區及大陸東莞皆有自有生產線，所有的設計、生產、製造... 都將由我們專業相關人員全程參與及服務。大陸東莞廠佔地 2400 平方公尺有員工 60 名、台灣廠佔地 826 平方公尺有員工 15 名，我們有專業研發及生產品管相關人員全程以嚴密謹慎的心為您生產產品及把關，以符合您的需求並讓您安心。

秉持著穩定的品質，優良的價格，精益求精的技術，熱誠服務每一位客戶，我們深信企業及客戶間互惠共榮共存的理念，相信您的成長，也是健豪的成長！健豪的專業及熱誠，真心為您服務，並樂於成為您們長期的供應商！

All Right Enterprise Co. Lt., was founded in 1996 at Tucheng District, New Taipei City and was relocated in 2007 at Shulin District, New Taipei City. In the Year 2012 the business expanded and acquired a land at Bade District, Taoyuan City. Which occupies an Area of 826 pings. Manufacturing Round cables (Audio, DC, USB 2.0 and 3.0, SATA, DVI, HDMI, display port, Type C cables, waterproof cables, PoE, Security / Surveillance cables, etc.) Flat cables, Adaptors, Wire Harnesses and OEM cables. Committed to meet and supply the International and latest electronics industry !

We have our own production lines in Bade District in Taiwan and Dongguan in Mainland China, all of which are designed and manufactured by our professional staff. Our Dongguan factory in Mainland occupies an area of 2400 pings has 60 employees and Bade District factory in Taiwan occupies an area of 826 pings has 15 employees. We have a professional and production quality control personnel to produce products to meet your needs and make you feel at ease.

Delivering sincere and quality service is our number 1 thrust. Be one amongst our valued customers who have been our satisfied, loyal and long term partners .

TEST EQUIPMENTS & MACHINES



拉拔測試機台



EDX元素分析儀



LOGIC ANALYZER
SPECTRUM ANALYZER



OSCILLOSCOPE



SIGNAL GENERATOR
OSCILLOSCOPE





Profile + Index + Equipment	01
Waterproof Cable - RJ45 (8P8C) Series	03
Waterproof Cable - M12 & M8 Series	07
Type C Cable	09
USB 3.0 Cable	14
USB 2.0 Cable	17
DVI & HDMI & DisplayPort Cable	20
Automotive Cable	22
Computer Cable	23
VGA Cable + IEEE488 Cable	24

LAN Cable	25
Medical Cable + SATA Cable	27
Audio & Video & TV Cable + Power Cable & MD Cable	28
OEM Cable + Access Control Cable	31
Changer & Adaptor	32
Wire Harness	33
Portable Video/CCTV Test Monitor	36
Certificate	38



WAVEFORM GENERATOR
LAB. DC POWER SUPPLY



CABLE/HARNESS TESTER



PLASTIC INJECTION
MACHINE



CCD MICROSCOPE



WIRE CUTTING MACHINE



WIRE CUTTING MACHINE



TERMINAL
MACHINE

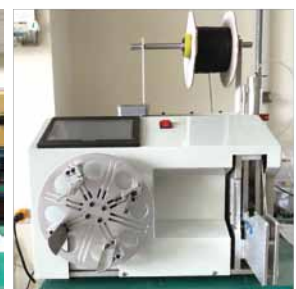

WINDING MACHINE

Waterproof Cable-RJ45(8P8C) Series

RJ45 Female Waterproof Connector



Product Specification

Material	-
Plastic	PBT color: Black 94V-0
Contact	Phosphor-bronze
Plating	-
Terminal	Contact Plating: 30μ" gold over 50μ" Nickel min.
Solder Tail	120μ" min Tin over 50μ" Nickel min.
Mechanical	-
Extraction Force	2.3 Kgf Min.

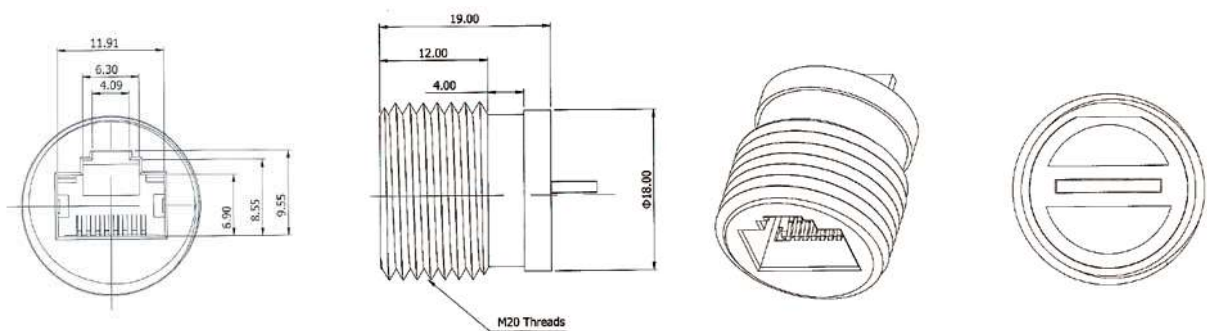

Product Specification

Material	-
Plastic	PBT color: Black 94V-0
Contact	Phosphor-bronze
Plating	-
Terminal	Contact Plating: 30μ" gold over 50μ" Nickel min.
Solder Tail	120μ" min Tin over 50μ" Nickel min.
Mechanical	-
Extraction Force	2.3 Kgf Min.

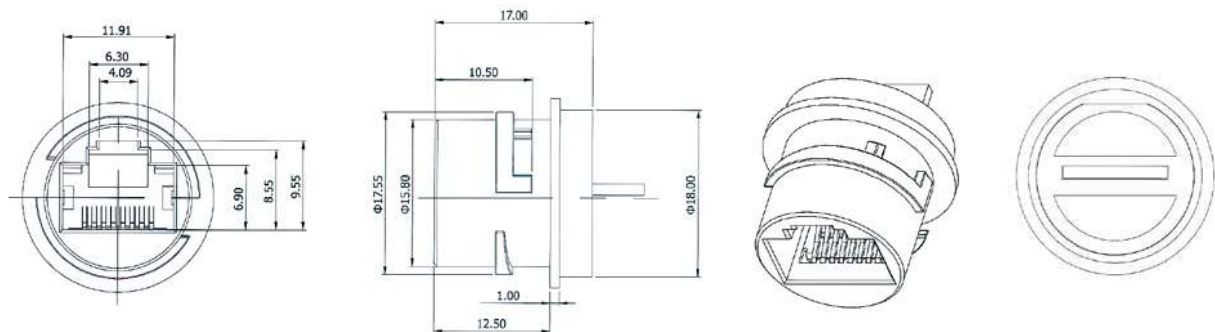

RJ45 (8p8C) Plug to RJ45 (8P8C) Jack Waterproof Cable, screw type IP68



RJ45 (8P8C) Plug to RJ45 (8p8C) Jack Waterproof Cable, push-on type, IP67



RJ 45 (8P8C) jack + 2 Pin Terminal Housing*4 to Housing*3 Waterproof Cable, push-on type



RJ 45 (8P8C) Jack to Housing*1 Waterproof Cable, push-on type



Waterproof Cable-RJ45(8P8C) Series

RJ 45 (8P8C) Jack + 4 Pin Terminal housing (w/cap) + 3 Pin Terminal Housing (w/cap) + Stereo Jacks (3.5mm)*2 to Housing*2



RJ 45 (8P8C) Jack to Housing Waterproof Cable, push-on type



RJ45 (8P8C) Jack (Push on Type)+2 Pin Terminal Housing*3 to Housing*5 Waterproof Cable



RJ45 (8P8C) Jack+2 Pin Terminal Housing to Housing*2 Waterproof Cable, push-on type



RJ45 (8P8C) (Push on type) + Stereo Jack*2 + 2Pin Terminal Housing*3 to Housing*5 Waterproof Cable



RJ 45 (8P8C) (push-on type) Jack + 2 Pin Terminal Housing *5 to Housing*3 Waterproof Cable



RJ 45(8P8C) Jack to Housing Waterproof Cable, push-on type



RJ 45 (8P8C) Jack + 2 Pin Terminal Housing to Housing*3 Waterproof Cable, push-on type



RJ 45 (8P8C) Jack + 2 Pin Terminal Housing*2 + Housing*3 Waterproof Cable, push-on type



RJ45 (8P8C) Jack+ 2 Pin Terminal Housing*2 to Housing*3 Waterproof Cable, push-on type



RJ 45 (8P8C) Jack+ 2 Pin Terminal Housing*2 to Housing*2 Waterproof Cable, push-on type



RJ45 (8P8C) Jack+ Stereo Jack + 2 Pin Terminal Housing*5 to Housing*3



Waterproof Cable-M12 & M8

8 Pin Connector to M12 8 Pin Connector *2



8 Pin Connector +3 Pin Connector + 2 Pin Terminal Housing*2 + 4 Pin Terminal Housing to Housing*3



4 Pin Connector w/screw + Stereo Jack to Housing*2



4 Pin Connector (Jack)+4 Pin Terminal Housing to Housing*3



5 Pin Connector to cable end



5 Pin Female to U S B 2.0 Type A Male



4 Pin Male to USB 2.0 Type A Female



8 Pin Male to RJ45 (8P8C) plug



4 Pin Male to Power 3 Pin Male



4 Pin Female to Power 4 Pin Female



8 Pin Male to RJ 45 (8P8C) Jack



8 Pin Female to DB9 Pin Male



Type C Cable

USB 3.1 Type-C to USB 3.1 Type-C Cable



Product Specification

Connector Type	USB Type C Male to Type C Male
Connector	Full Function Type C Male
Jacket Material	TPE
Maximum Transfer Rate	10Gbps
Supply Voltage	20V Max
Supply Current	5A Max
Color	White / Black (Can Be Customized)
Length	0.5M (Can Be Customized)
Connector Jacket	Metal Shell

USB 3.1 Type-C to USB 3.0 A Type Male



USB 3.1 Type-C to USB 3.0 A Type Male



USB 3.1 Type-C to USB 2.0 A Type Male



USB 3.1 Type C Cable (Right angle & wall-mounted type)



USB 3.1 Type C Male w/thumbscrew Cable



USB 3.1 Type-C to VGA Adaptor Cable



- USB 3.1 to VGA Display Adapter. Resolution Supported 1920X1080 , 1600X1200 , etc .
- Allows you to connect an extra monitor to your Mac .
- Without external power supply , support plug and play .
- Flexible design concept , truly Personal Emergency .
- Without driver CD , without restart the computer .
- Product resolution up to 720P/1080i /1080P .
- Product inputs : USB 3.1 Type C .
- Product output terminal : VGA .
- The USB 3.1 to VGA adapter used to control the extra screen uses very little computer resource and offers a vast array of screen resolution and color depths .

USB 3.1 Type-C to DVI Adaptor Cable

- Input port : use latest USB 3.1 Type-Cport .
- USB 3.1 Type-C port is about 8.25 x 2.4mm .
- USB 3.1 Type-C port have 24 pinend , Support positive and negative plug .
- Data transfer speed can be USB 3.1 10Gbps .
- Slim design , mini size .
- Output port : link with HDMI equipment like : Display projector TV with HD DVI device like : External device for display projector TV with high definition digital signal .



USB 3.1 Type-C to Displayport Adaptor Cable



- Supports 3D, 4K x 2K video and more color spare.
- A premium quality HDMI to HDMI cable is suitable for use in HDTC, home theater, DVD player, projector, PS3, Xbox360 and other HDMI devices.
- Compatible with multiple audio formats from stereo to multi-channel sound.
- Transfer Digital Audio & Video signals at warp speed of 10.2 Gigabytes per second.

Type C Cable

Mini Displayport to HDMI Adaptor Cable



- With chipsets .
- Function : connect the devices with A Type-C port such as cellphone / tablet / rotebook to high-definition display , monitor and HDTV that has DP ports .
- Full compatible with USB 3.1 standsrd .
- Support up to 4K x 2K @60Hz .
- Support both audio and video .
- Support reversible plug and play .
- 2 options for design .

Mini Displayport to HDMI Adaptor Cable

- Standard USB 3.1 Type-C .
- Support USB 3.1 input and HDMI output.
- Flexible USB Type-C Switching Support for USB 5G and Display Port 1.2 Alt made .
- Support per lane data rates of 5.4 Gbps (HBR2) , 2.7Gbps (HBR) and 1.62Gbps (RBR) .
- Support multiple color formats : RGB 6/8/10/12-bit per component (bps) and YCbCr4:4:4 , YCbCr4:2:2 , 8/10/12 bps .
- Support HDMI 1.4 and former versions.
- Support resolution up to 3840 x 2160 @30Hz (mirror mode) in DP 1.1 (or 1.2) in SST mode.
- Supports HDMI audio .
- Supports bus-powered and self-power operation .
- Compatible With : Nokia N1 tablet , Chromebook Pixel 2015 , MSI Gaming Notebooks , 12 " Apple Macbook and other devices with a USB 3.1 Type C port .



USB 3.1 Type-C to USB 3.0+DVI+Type-C Adaptor Cable



Introduction

This is a USB-C to USB 3.0 port , DVI-F(24+5) and USB-C charging port hub , allows you to connect a a USB device to a host computer or another hub , the USB-C female port can charge for the host computer , DVI port allows you to connect an extra monitor so that you can watch videos or slideshows on a big screen and the host computer can easily connect to the network through the It can work on Macbook or Google new Chromebook Pixel and other USB 3.1 Type C supported devices.

- Support USB-C , DVI , USB 3.0 , interface .
- Support USB 3.0 super speed (5Gbps) transmission , downward compatible USB 2.0 .
- Support DVI viedeo resolution max up to 3840 x 2160 .
- Support twisted pair crossover detection and auto-correction.
- USB-C female charging port for Macbook or Google new Chromebook Pixel and other USB-C supported devices charging .
- Multiple USB-C interfaces support plug and play , hot swap .

USB 3.1 Type-C to USB 3.0+VGA+Type-C Adaptor Cable



Introduction

This is a USB 3.1 Type C to USB 3.0 port , VGA port and Type C charging port hub, designed for connecting a USB devices from a host computer or another hub , the USB-C female port can charge for the host computer , VGA Adapter allows you to connect an extra monitor so that you can watch videos or port . It can work on Macbook or Google new Chromebook Pixel and other USB 3.1 Type C supported devices .

- Support USB 3.1/3.0 super speed (5Gbps) transmission, downward compatible USB 2.0.
- Support USB-C input and VGA output.
- Support USB 3.0 port output and speed up to 5bps.
- Support per lane data rates of 2.7 Gbps (HBR) and 1.62 Gbps (RBR) .
- Support resolution up to 1920 x 1080 @60Hz.
- USB 3.1 female charging port for Macbook or Google new Chromebook Pixel and other USB 3.1 Type C supported devices charging.
- Multiple USB3.1 interface support plug and play , hot swap.

USB 3.1 Type-C to USB 3.0+HDMI+USB 3.1 Type-C

Introduction

This is a USB 3.1 Type C to USB 3.0 port , Type C charging port and HDMI port hub . Designed for connecting a USB device from a host computer or another hub , the USB-C female port can charge and HDMI Adapter (DP Alt mode) allows you to connect an extra monitor so that you can watch videos or slideshows on a big screen . It can work on Macbook or Google new Chromebook Pixel and other USB 3.1 Type C supported devices .

- Support USB-C input and HDMI output .
- Support USB 3.1/3.0 super speed (5Gbps) transmission , downward compatible USB 2.0 .
- Support display port 1.2 alt mode .
- Support per lane data rates of 2.7Gbps (HBR) and 1.62Gbps (RBR) .
- Support multiple color formats : RGB 6/8/10/12-bit per component and YCbCr4:4:4 , YCbCr4:2:2 , 8/10/12bps .
- Support HDMI 1.4 and former versions .
- Conect protection of HDCP Rx and Tx keys to support HDCP repeater .
- Support resolution up to 3840 x 2160 @30Hz in DP 1.2 in SST mode .
- USB 3.1 female charging port for Macbook or Google new Chromebook Pixel and other USB 3.1 Type C supported devices charging .
- Multiple USB 3.1 interface support plug and play , hot swap Easy to use and carry .



USB 3.1 Type-C(M) to USB 3.1 Type-C(F)+3*USB 3.0 AF



Introduction

Connector . USB 3.1 / M to 3.0 HUB ports .

Plug : USB 3.1 reversible plug .

Transmission interface : USB 3.1.

Application : Suitable for Mac with USB 3.1 interface and mouse , card reader , etc .

- USB 3.1 interface , transfer rate up 10bps transmission Download compliant with USB version : 1.1/2.0/3.0 .
- USB hub support hot-swappable , plug and play , easy to use
- USB hub free driver supports Windows XP/Vista/7/8 & Mac OS , linux .
- Supports Full-speed (480Mbps) and Low-speed (12Mbps) USB device profiles .
- Support over current and unstant current protection .
- Extra USB Type C female port with PD to charge notebook .

Type C Cable

USB 3.1 Type C Male to USB 3.1 Type C, USB 3.0 Type A/B, USB Type C Power Delivery, HDMI, DisplayPort, Gigabit Ethernet (RJ45)

- **USB Type C 3.1 :**
Data transfer speed up to 10 Gbps, backwards compatible with USB 3.0 & 2.0 & with Windows 10, 8, and 7 and Mac OS 10 (no drivers required)
- **USB 3.0 Type A/B :**
Data transfer speed up to 5 Gbp/s
- **USB Type C Power Delivery:**
No data transfer but charge only at max. 80W thru USB 3.1Type C/F
- **HDMI :**
Resolution 4K*2K, 1080p at 60Hz or UHD (3840x2160) at 30Hz, available to HDMI-enabled display or likewise
- **DisplayPort & VGA :**
15 pin , to present quality image and streaming on display /visual devices
- **Gigabit Ethernet port (RJ45(8P8C)) :**
USB bus-powered, enable you to enjoy the ultra-fast Gigabit's Ethernet speeds and the reliability of wired connection directly.



USB 3.0 Cable

USB 3.0 A Type Male to Male Cable



USB 3.0 A Type Male to B Type Male



USB 3.0 A Type Male to B Type Male (W/Thumb Screw) Cable



USB 3.0 A Type Male to Female Cable



USB 3.0 Type A Plug to RJ45 (8P8C) Plug



USB 3.0 Cable

USB 3.0 A Type Male to Female Cable



USB 3.0 Cable , 2* A Type Female to 20p Housing



USB 3.0 Cable , 2* A Type Female to 20p Housing



USB 3.0 + Audio Cable



Micro USB 3.0 w/thumbscrews Male Cable
(Right angled 90 degree)

Micro USB 3.0 w/thumbscrews Male Cable
(Straight)

Micro USB 3.0 w/thumbscrews Male Cable
(Right angled 90 degree)



USB 3.0 A Type Male + Stereo Plug to (for panel)
USB 3.0 A Type Jack + Stereo Jack (3.5mm) Cable

USB 2.0 B Type Female w/ cover
(for panel) Cable

USB 2.0 B Type Female (for panel) Cable

USB 3.1 Type C Female (for panel) Cable

USB 3.0 A Type Female +
Stereo Jack (for panel) Cable

Changer HDMI Female to HDMI Female

Changer Micro USB B Type Female to
Micro USB B Type Female



USB 2.0 Cable

USB 2.0 A Type Male to Male



USB 2.0 A Type Male to Female Cable



USB 2.0 A Type Male to Female



Micro USB Right Angle to 6p Housing



Mini USB Right Angle Type



USB 2.0 B Type Female Cable



USB 2.0 A Type Female Dual Type to 2*DuPont 2.54mm 5p Housing+ 2*DuPont 2.0mm 5p Housing



USB 2.0 Type Female(Pitch 26mm) to 4p Housing Cable

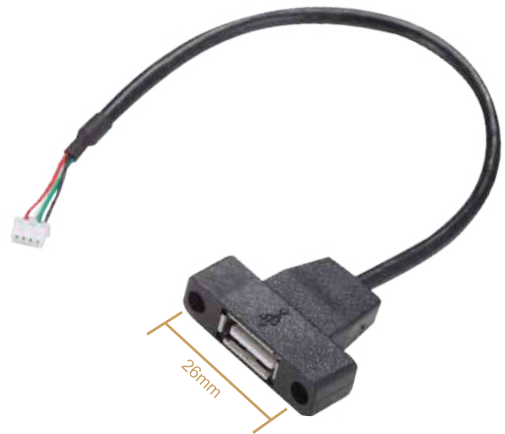

USB 2.0 A Type 2*Female to DuPont 10p Housing Cable



USB 2.0 Cable

USB 2.0 A Type 2 port Female to 2*4p Housing Cable

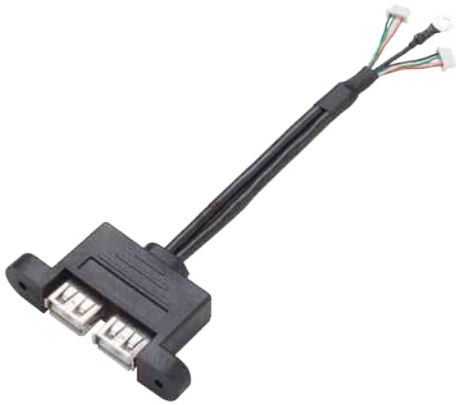

USB 2.0 A Type 4*Port Female to 2*DuPont 2.54mm 10p Housing



Power USB 24V to DC Jack



Power USB 24V to USB B Type+Power 3p (Lock Type)



USB 2.0 A Type Male+Power 3p (Lock Type) to USB 2.0 B Type Male+DC Plug Cable



DVI & HDMI & DisplayPort Cable

Mini HDMI Cable Male to Male



HDMI Male to Displayport Male



HDMI Female to Displayprot Male cable



Mini Display Male to HDMI Female



Mini HDMI Male to Male Cable



HDMI to DVI Cable



DVI & HDMI & DisplayPort Cable

HDMI Male to VGA 15 Pin Female



DisplayPort to HDMI Female



DisplayPort to VGA 15 Pin Female



DisplayPort to DVI Female



Automotive Cable

17 Pin Male to Female Cable, Connector W/Screw Type



Car Cable 26 Pin Plug W/ Screw



Car Cable 16 Pin plug to 16 Pin Jack



Car Cable 24 Pin Adaptor to RJ45 (8P8C) Jack +Stereo Jack(in/out) + DC Power Jack



Car Cable 9 Pin Jack to 16 Pin Jack



Computer Cable

Power 4p to Power 4p Lock Type
Scsi Cable HPCEN 26p Male to Male W/Latch Type
USB 3.0 Cable A Type to B Type (Thumb Screw)
LAN Cable RJ45 (8P8C) Male to Male



D-SUB 25p Cable (Samll Size Tooling)



HD26P Male to HD26P Male Cable



Modem Cable :
D-SUB 9p Female to D-SUB 25p Male
D-SUB 9p Male to D-SUB 25p Female
Null Modem Cable :
D-SUB 9p Female to D-SUB 25p Male
D-SUB 9p Male to D-SUB 25p Female
D-SUB 9p Female to D-SUB 25p Female



SCSI Cable



VGA Cable + IEEE488 Cable

VGA Cable

VGA Cable

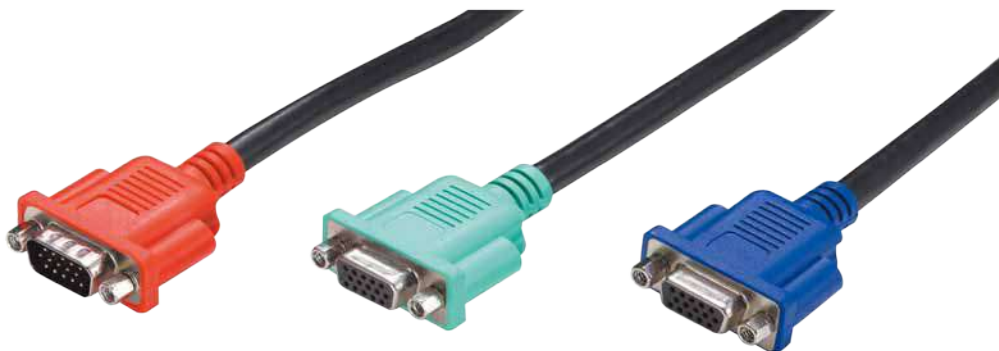

VGA Cable , HD15P Male to HD15P Male +DC Plug

VGA Cable , HD15P Male (Right Angle) to Mini Din 8p+DC Plug



IEEE488 Cable

IEEE-488 GPIB Cable Assembly Type (Metal Hood)



LAN Cable

RJ45 (8P8C) Jack to 8Pin Terminal Adaptor Cable



RJ45 (8P8C) Plug to 8Pin Terminal Adaptor Cable



RJ45 (8P8C) Plug to 8Pin Terminal Adaptor



RJ45 (8P8C) Plug to RJ45 (8P8C) Plug Cable



RJ45 (8P8C) Plug to RJ45 (8P8C) Plug Cable, Cat. 6 UTP Cable



RJ45 (8P8C) Plug to RJ45 (8P8C) Plug Cable



RJ45 (8P8C) Plug to RJ45 (8P8C) Jack
Cat.5e STP Cable



RJ45 (8P8C) Plug to RJ45 (8P8C) Jack
Cat.5e UTP Cable



RJ45 (8P8C) Plug to RJ45 (8P8C) Jack Cable



Cat.6 Cable , RJ45 to RJ45



Telephone Line 4P4C to 4P4C Coil Cable



RJ45 (8P8C) Plug to RJ45 (8P8C) Jack Cable



Medical Cable + SATA Cable

Medical Cable

VGA+MIN DIN 6P*2 to SCSI 20P+DB9 M*2+DB9 F*2



SATA Cable

E-SATA Male to Female



SATA Cable



SATA Cable

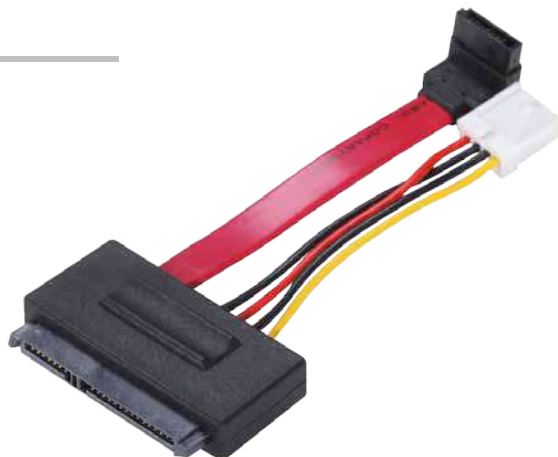

Audio & Video & TV Cable + Power Cable & MD Cable

Audio & Video & TV Cable

2*RCA Plug to 2*RCA Plug Right Angle Type



RGB Cable , 3*RCA Plug to 3*RCA Plug



3.5mm Stereo Plug to 2.5mm Stereo Plug



3.5mm 4 Port Jack+SR to 2.5mm Stereo Jack+DC Plug



Power Cable & MD Cable

PS-2 Cable , 2*Mini Din 6p (K.B & Mouse) to 10p Housing



RJ8 (4P4C) to Mini Din 10p Cable



Audio & Video & TV Cable + Power Cable & MD Cable

Power 3p Male to Power 3p Male ,
Assembly Lock Type



Power 3p Male to Power 3p Male , Assembly Lock Type
Power 4p Male to Power 4p Male , Assembly Lock Type



Power 4p Female Molded W/Lock Type
Power 3p Female Molded W/Lock Type



Power 3p & 4p Cable , Molded Type





DC Plug to DC Jack Molded W/Waterproof Cable (5.5*2.5mm & 5.5*2.1mm)



DC Power Cable , DC Jack W/Screw Type



DC Plug+Cord to DC Plug Cable (5.5*2.5mm & 5.5*2.1mm)



PS-2 Cable Mini Din 6p Male to Male



PS-2 Cable , Mini Din 6p Male to Female (Apple Tooling)



OEM Cable + Access Control Cable

OEM Cable

14p Box Header to RJ45 (8P8C) Plug ,
Coil Cable



3W3C cable



DMX 3P Plug w/push-on to RJ45 Jack Cable



USB 3.1 Type E



Access Control Cable

DB9 9 Pin w/3.5 mm stereo jack to Housing Cable



Changer & Adaptor

Mini Gender Changer
D-SUB 9p & 15p & 25p & 37p (M/M , M/F , F/F)
HD15P (M/M , M/F , F/F) M : Male , F : Female

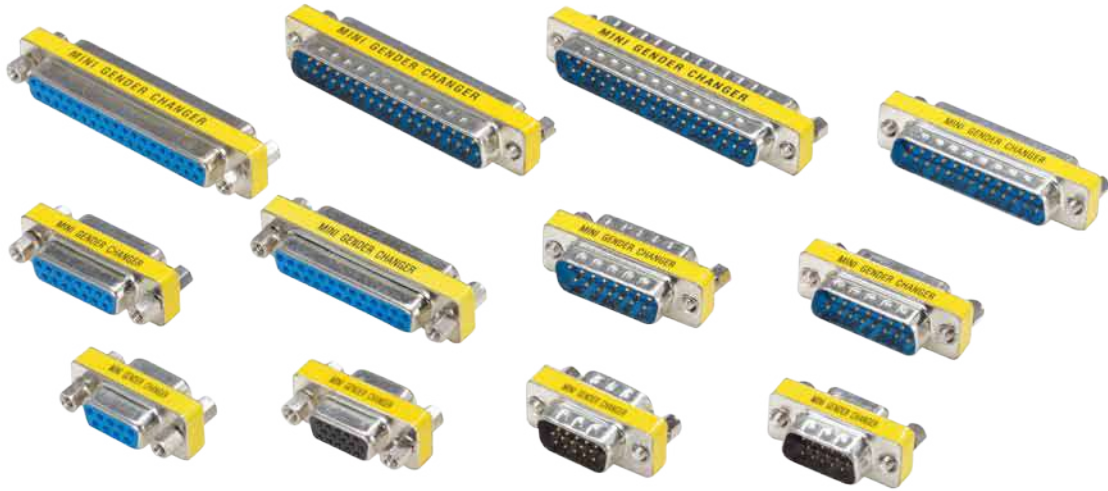

USB 3.1 Type-C Male to
USB 3.0 A Type Female Adaptor



USB 3.1 Type-C Male to Female Adaptor



HDMI Female to Female Adaptor



DC Jack to Mini USB 5p Male Adaptor



Wire Harness

Automotive Wiring



ATX Power Cable

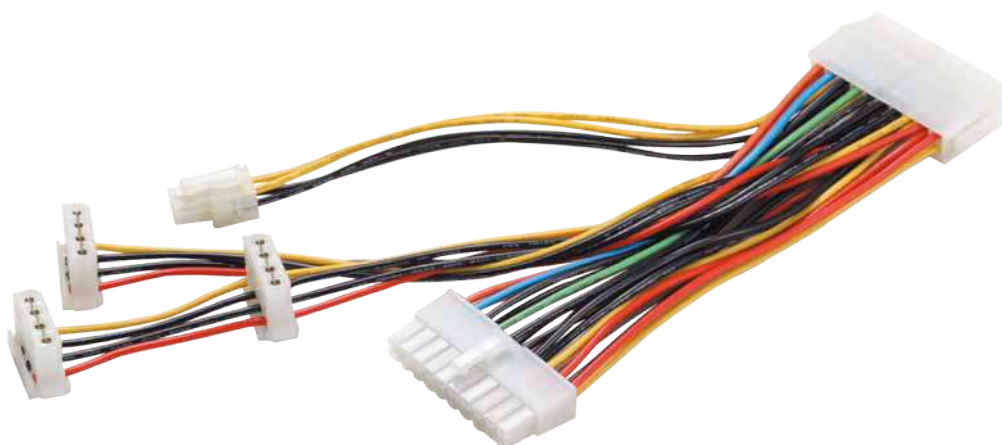

Wire Harness

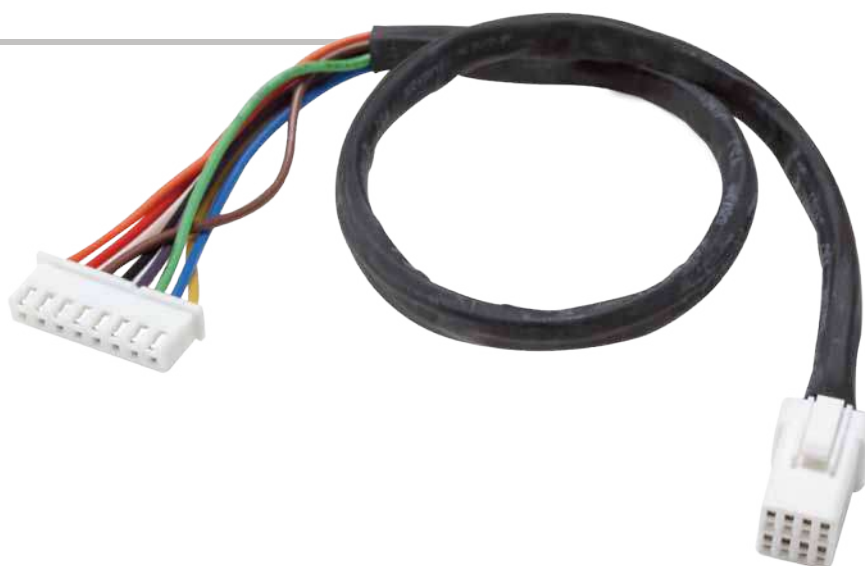

Wire Harness

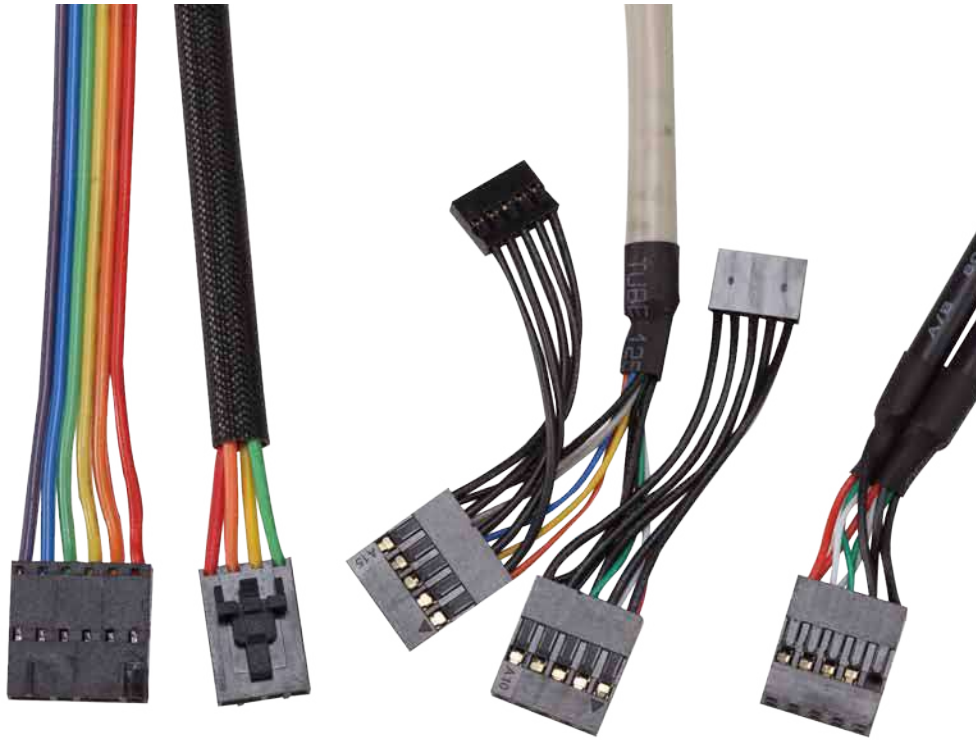

Wire Harness



Wire Harness

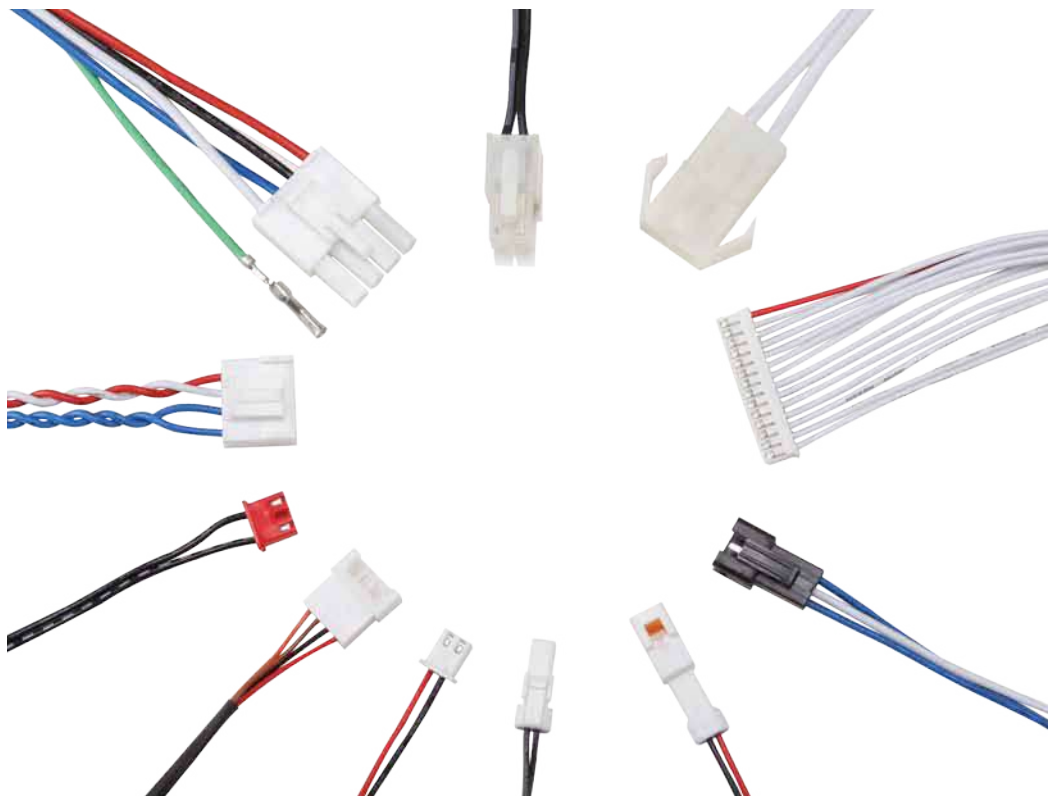

Wire Harness

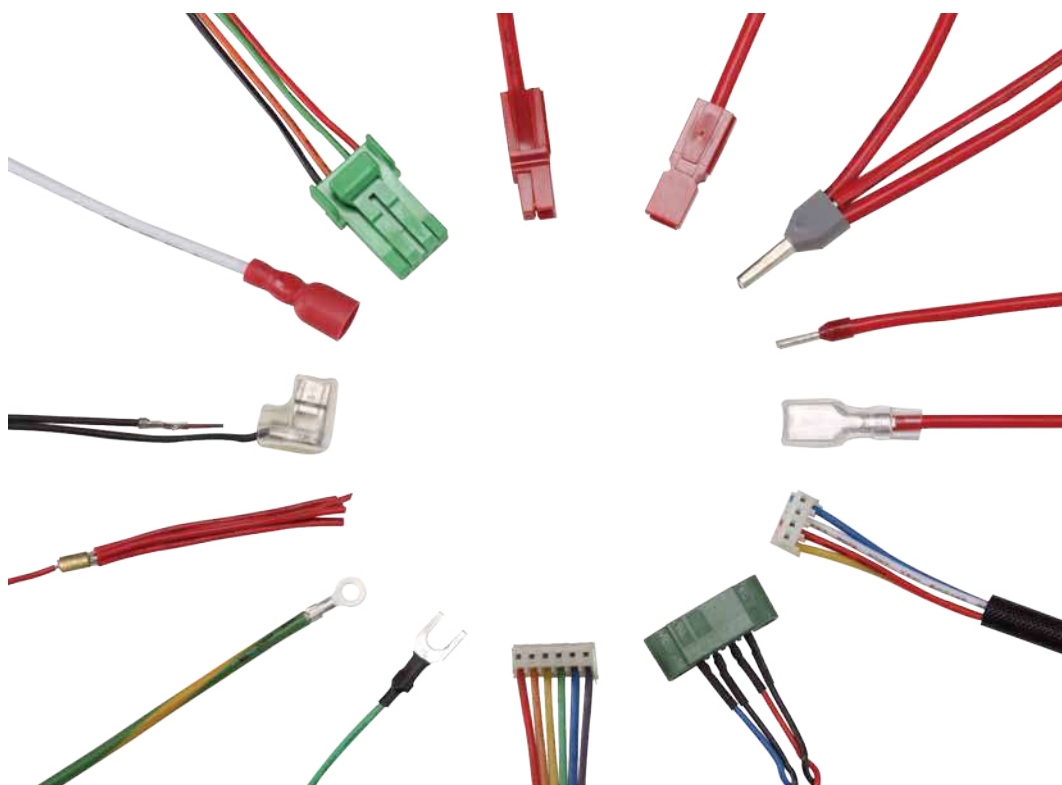

Portable Video/CCTV Test Monitor

7 Inch Portable LCD Test Monitor

P/N : ART-CM70-A

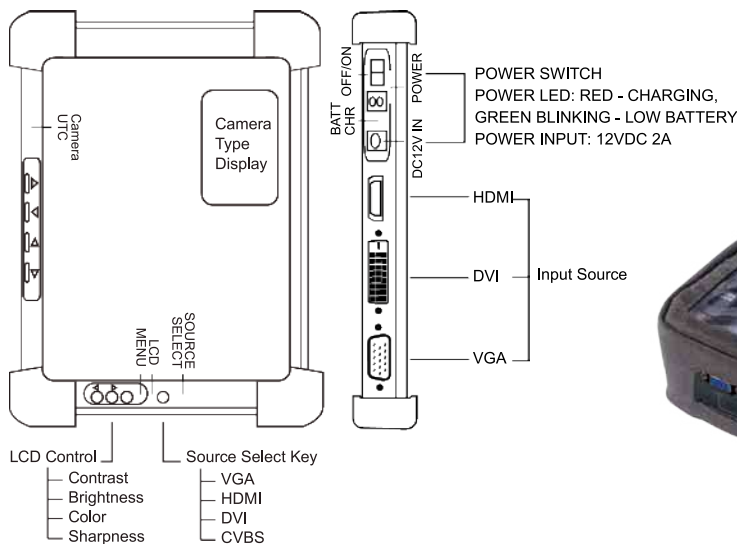

Introduction

The 7 inch LCD test monitor supports HD-TVI, HDCVI, AHD, and CVBS cameras up to 8MP. Includes HDMI, DVI, and VGA video inputs and a CVBS BNC loop out. A camera type indicator provides information on your camera (type and resolution) with a guideline indicator to allow adjustment of the camera angle. UTC control is also provided for compatible cameras. Powered by a removable li-ion battery for up to 2 hours of usage or add in a second battery to increase usage up to 4 hours.

Specifications

● LCD Size	7 inches	● Input Connector	HDMI / DVI / VGA / HD Analog (BNC)
● Display Ratio	16:9	VGA	800x600@60HZ ~1280x768@60HZ
● Backlight	LED	HDMI	HDMI 1.3/1.4 / HDCP 1.2 HDMI 3D, HDMI 4Kx2K, HDMI ARC
● Brightness	180-230 cd/m2	DVI	DVI 1.0 MAX 16:9 1920x1080@60HZ DVI 1.0 MAX 4:3 1600x1200@60HZ
● Resolution	1024x3 (RGB)x600	● Camera Resolutions	HD-TVI, HDCVI, AHD: Up to 8MP CVBS: 960H
● View Angle (U, D, L, R)	60 / 65 / 65 / 65	● Output Connector	CVBS
● Display Dimensions (mm)	165.75(W)x105.39(H)x3.0(D)	● DC Power Input / Output	12V DC 2A Input (Charges Monitor) 12V DC 1A Output (Powers Camera)
● Working Voltage	DC11-13.5V	● Battery (18650 Li-ion)	5200mA / 2 Hour 10400mA / 4 Hour (Optional 2nd battery added)
● Working Current	DC630mA±30mA		
● Power Consumption	7.5W (TYP)		
● Start Time	8~12 Sec		
● Working Temperature	-0°~50°C		
● Storage Temperature	-20°~70°C		
● Environment Humidity	5~70% RH		

Portable Video/CCTV Test Monitor

Portable LCD Test Monitor for TVI/AHD/CVBS Tester Monitor

P/N : ART-C35-A





- 4.3 Inch TFT LCD Monitor
- Designed for adjusting focus & angle
- Connect and test synchronously
- Format : TVI, AHD, CVI: Up to 5MP; HD-TVI up to 8MP
- Power charge : 3 hours
- Power : 12V DC 3
- BNC port : Loopout
- Signal down converted to NTSD
- Optional display as a TV
- Optional DC power for camera

Set packaging

● TVI/AHD/CVBS Test Monitor	x 1
● 12V DC Power Adapter	x 1
● 2ft BNC Male to Male Cable	x 1
● 2ft DC Male to Male Cable	x 1
● Carrying case	x 1
● Users Manual	x 1



MS CERT
Certificate Of Registration
QUALITY MANAGEMENT SYSTEM
 This is to Certify that the Quality Management System
 of
ALL-RIGHT ENTERPRISE CO. LTD.
 Address: No.53, Minquan St., Bade Dist., Taoyuan City 334, Taiwan (R.O.C.)
 has been assessed and found to comply with the requirements of:
ISO 9001:2015
 (Quality Management System)
 Scope of Certification:
 Manufacturing and Sales of Wire harness, Cable Assemblies, and Cable Accessories.
 Sector Code: (ANZSIC CODE: 2431)
 Certificate Number: **TWN/QMS/00356/7305**
 Issue no.: 01
 Date of approval : 12.12.2018 Valid until : 11.12.2021
 Revision no: nil Revision date : nil
 Original Certification Date: 12.12.2018

 Head of Certification

MS CERT ACC.NA.M0131000K
MS CERTIFICATION SERVICES PVT. LTD.
www.msccertification.net
 The validity of this certificate can be verified at www.jas-anz.org/register
 or www.msccertification.net
 The Certificate is Valid Only if the Annual Surveillance Mark is Signed by Auditor on Original.
 F40 rev.03

CERTIFICATE OF COMPLIANCE

Certificate Number: 20130709-E355330
 Report Reference: E355330-20120629
 Issue Date: 2013-JULY-09

Issued to: ALL RIGHT ENTERPRISE CO LTD
 6TH FL 528 DA AN RD SHULIN DIST
 NEW TAIPEI CITY 238 TAIWAN

This is to certify that representative samples of **COMPONENT - WIRING HARNESSSES**
GENERAL COVERAGE

Have been investigated by UL in accordance with the Standard(s) indicated on this Certificate.

Standard(s) for Safety: Subject 764 - Wiring Harnesses
 Additional Information: See the UL Online Certifications Directory at www.ul.com/directory for additional information

Only those products bearing the UL Recognized Component Mark should be considered as being covered by UL's Recognition and Follow-Up Service.
 The UL Recognized Component Mark generally consists of the manufacturer's identification and catalog number, model number or other product designation as specified under "Marking" for the particular Recognition as published in the appropriate UL Directory. As a supplementary means of identifying products that have been produced under UL's Component Recognition Program, UL's Recognized Component Mark "RM" may be used in conjunction with the required Recognized Marks. The Recognized Component Mark is required when specified in the UL Directory preceding the recognitions or under "Markings" for the individual recognitions.
 Recognized Component Mark "RM" may be used in conjunction with the required Recognized Marks. The Recognized Component Mark is required when specified in the UL Directory preceding the recognitions or under "Markings" for the individual recognitions.
 Recognized components are incomplete in certain constructional features or restricted in performance capabilities and are intended for use as components of complete equipment submitted for investigation rather than for direct separate installation in the field. The final acceptance of the component is dependent upon its installation and use in complete equipment submitted to UL LLC.
 Look for the UL Recognized Component Mark on the product.

 Page 1 of 1

D-U-N-S® CERTIFIED
D-U-N-S® Certified Profile Validity: 2018 Dec 11 - 2019 Dec 10

Business Basic Information 

D-U-N-S® Number: 65-865-3357
 Business Registration No.: 89807582
 Company Name: ALL RIGHT ENTERPRISE CO., LTD.
 Company Type: a private limited company
 Company Operating Address: No. 53, Minquan St., Bade Dist., Taoyuan City, Taiwan (R.O.C.)
 Phone: +886-3-3652789
 Fax: +886-3-3653789
 Mobile:
 Email: service@all-right.com.tw
 Company Website: <http://www.all-right.com.tw>
 Taiwantrade Website of Company: <http://all-right.en.taiwantrade.com>
 Line of Business: Manufacturer of Cable assemblies, Cable accessories, Cables
 Main Products: 1. Cable assemblies 2. Cable accessories 3. Cables
 Brand Name: AR
 Agency Held
 SIC Code: 35779005
 Employee Here: 20-49
 Employee Total: 20-49

Business Registration Information 

Registration Date: 1995/12/15
 Authorized Capital: TWD 5,000,000
 Paid Up Capital:
 Registration Address: 桃園市八德區長權街53號
 Name of Representative: Hsieh, Kuei Ying
 Registration Authority: Taoyuan City Government

Management Information 

Name	Jobtitle	On board date
Hsieh, Kuei Ying	Management Executive	

Taiwantrade Supplier Verification

Verification No.: 000057897 001
ALL RIGHT ENTERPRISE CO., LTD.
 傑豪興業有限公司
<https://all-right.en.taiwantrade.com/>

Offsite verification of the following areas was conducted
 by TÜV Rheinland Taiwan Ltd.

Basic Information Operation Information
 Management Information

Valid from 2017/09/26 until 2018/09/25

 Date of Issue: 2017/09/26
 TÜV Rheinland Taiwan Ltd.
 11F, No. 758, Sec. 4, Bade Rd.,
 Taipei 108, Taiwan

 JIAO J. S. WU
 TÜV Rheinland Systems Greater China
 201102026

www.tuv.com  **TÜVRheinland®**
 Precisely Right.

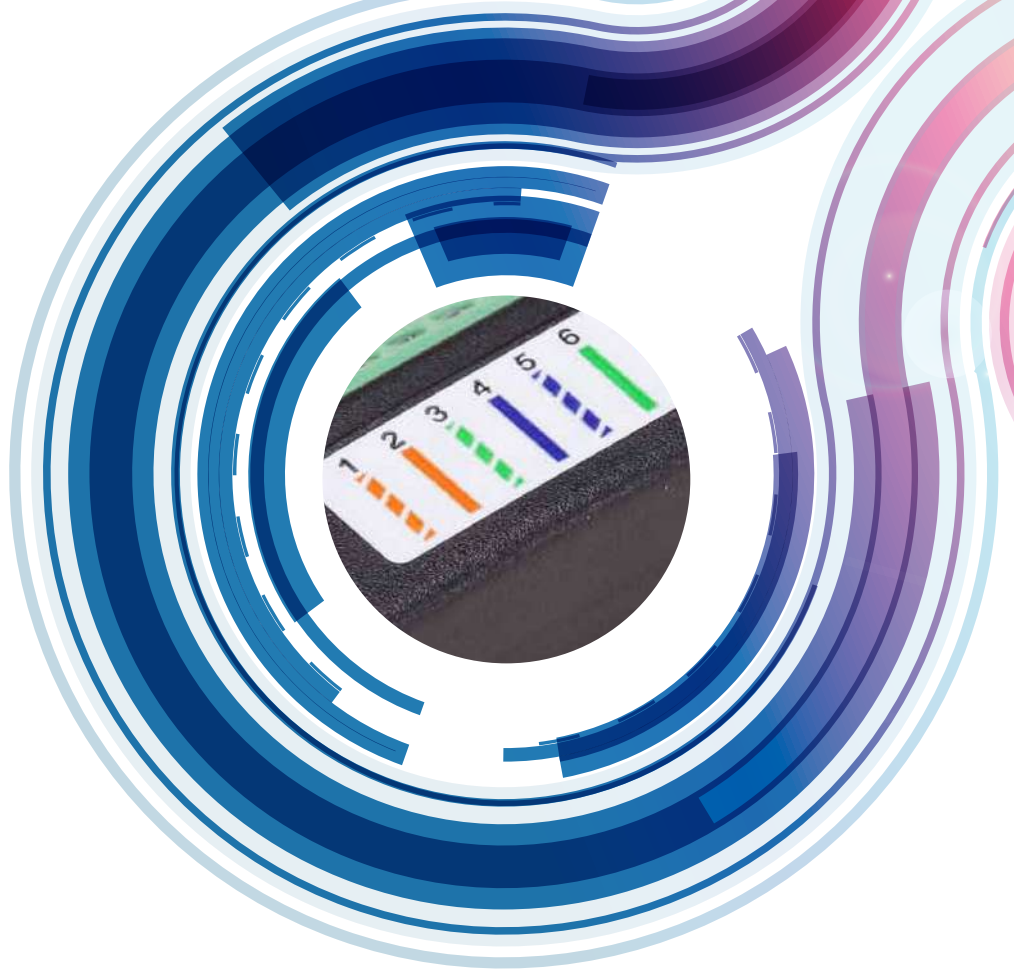

捷豪興業有限公司
ALL RIGHT ENTERPRISE CO., LTD.

台灣公司

33447 桃園市八德區民權街53號
No.53, Minquan St., Bade Dist.,
Taoyuan City 334, Taiwan (R.O.C.)
TEL +886 3 365 2789
FAX +886 3 365 3789



大陸工廠

523 東莞市厚街鎮沙塘沙隆路朗創工業園區C棟3F



service@all-right.com.tw
www.all-right.com.tw